



Roots

718 URAI

Part Number – 65122020



- Detachable steel mounting feet
- Rigid one-piece cast iron casing
- Connections in standard pipe sizes
- Straight, precision machined two-lobe impellers
- Splash oil lubricated gears
- Carburized and ground alloy steel spur timing gears
- Anti-Friction gears
- Ground steel shafts
- Center Timed for rotation in either direction

Also Available in:

- URAI-Metric

Equivalent to:

Sutorbilt Model 7LP

Tuthill Model 7018



816-741-0282



Quick Specs

Flow Range	to 2316 CFM
Max ΔPressure	7 PSI
Max ΔVacuum	12" Hg
Maximum RPM	2050
Minimum RPM	545
Max ΔT	130°F
Connection Size	8" Flange
Shaft Dia.	1.562"
Min Sheave Dia.	9.5"
Drive End Lubrication	Grease
Gear End Lubrication	Oil
Oil Sump Gear End Horiz Config	~59.5 oz
Oil Sump Gear End Vert Config	~32.3 oz
Bare Unit Weight	650 lbs
Container	Wood Skid
Skid Size (L x W x H)	54" x 32" x 36"
Shipping Weight on Skid	~685 lbs
Recommended to Ship Via	Truck



816-741-0282

**Universal RAI Series Blowers Parts List
6" & 7" Gear Diameter**

(Refer to drawing #64792023)

Item #	Part Name	Qty.
1	Headplate Gear End	1
2	Headplate Drive End	1
3	Gearbox	1
4	Timing Gears	2
5	Cover-Blind (Plug Opening)	1
7	Gasket, Gear Box	1
11	Cylinder	1
12	Impeller & Shaft Drive	1
13	Impeller & Shaft Driven	1
14	Bearing, Ball	3
15	Bearing, Roller	1
16	Pin, Dowel	4
17	Gear Nut	2
19	Key	1
21	Plug, Pipe	3
23	Screw Hex Nylock	8
25	Breather (Plug Vent)	1
26	Screw, Hex	*
27	Seal, Lip Bearing	4
29	Washer, Spring Wavy	2
31	Screw, Hex, Nylock	4
32	Screw, Hex	10
33	Seal Lip-Drive	1
34	Clamp Plate	2
35	Foot	2
37	Fitting, Grease	2
38	Fitting, Relief	2
39	Washer Mounting	4

*Quantities vary by blower.

Table 2 - Recommended Oil Grades

Ambient* Temperature °F (°C)	ISO Viscosity No.
Above 90° (32°)	320
32° to 90° (0° to 32°)	220
0° to 32° (-18° to 0°)	150
Below 0° (-18°)	100

*Ambient temperature is defined as the temperature of the space in which the blower and drive are located.

Due to sludge build-up and seal leakage problems, Roots recommendation is DO NOT USE Mobil SHC synthetic oils in ROOTS blowers.

- When servicing drive end bearings of a AIR (Non Gas) blower, use the specified and recommended Shell Darina SD 2 NLGI #2 product code 5067628.
- Lithium based greases are not compatible with the specified and recommended Shell Darina SD 2 grease used when assembling the blower. **Lithium based grease is not approved for any ROOTS blowers.**

Repair Kits

Repair kits are bundled with the parts you need to complete a standard repair. It is more cost effective to buy a repair kit than to purchase individual parts.

However, if you need parts not listed in the kit, it is recommended that you call Pathfinder Systems for parts pricing.

P/N 651190RK Kit without Gears for 76, 711, 718 URAI, URAI-Metric

Item	Qty	7" Kit Description	P/N
5	1	PLUG,OPENING FOR 4.331	12957007
7	2	GSKT,GRBX 7 URAI TS9003	64944021
14	3	BRG,BALL	10987044
15	1	BRG,ROLLER	10222039
17	2	NUT,HEX ESNA 1 1/4-12	10319019
27	4	SEAL,LIP(VITON) 1-5/8 S	10460037
29	2	WSHR,SPR WAVY 4.300 OD	10135006
31	4	SCR,CAP HEXH NYL 3/8-16X	10677012
33	1	SEAL,LIP for GREASE LUBE	10005174

P/N 651180RK Kit with Gears for 76, 711, 718 URAI, URAI-Metric

Item	Qty	7" Kit Description	P/N
4	1	GEAR, ASSY 7 URAI	64943021
5	1	PLUG,OPENING FOR 4.331	12957007
7	2	GSKT,GRBX 7 URAI TS9003	64944021
14	3	BRG,BALL	10987044
15	1	BRG,ROLLER	10222039
17	2	NUT,HEX ESNA 1 1/4-12	10319019
27	4	SEAL,LIP(VITON) 1-5/8 S	10460037
29	2	WSHR,SPR WAVY 4.300 OD	10135006
31	4	SCR,CAP HEXH NYL 3/8-16X	10677012
33	1	SEAL,LIP for GREASE LUBE	10005174

ROOTS® Synthetic Oil: ISO-VG-320 Grade

	Part Number
Quart	13106004
Gallon	13106005
Case (12 qts)	13106007

ROOTS® Synthetic Oil: ISO-VG-220 Grade

	Part Number
Quart	13106001
Gallon	13106002
Case (12 qts)	13106008

ROOTS® Synthetic Oil: ISO-VG-150 Grade

	Part Number
Quart	13106020
Gallon	13106021
Case (12 qts)	13106023
5 Gallon Pail	13106022
55 Gallon Drum	13106025

ROOTS® Synthetic Oil: ISO-VG-100 Grade

	Part Number
Quart	13106011
Gallon	13106012
Case (12 qts)	13106014
5 Gallon Pail	13106013
55 Gallon Drum	13106016

REV.	PART NAME	QTY.	MAT'L.
------	-----------	------	--------

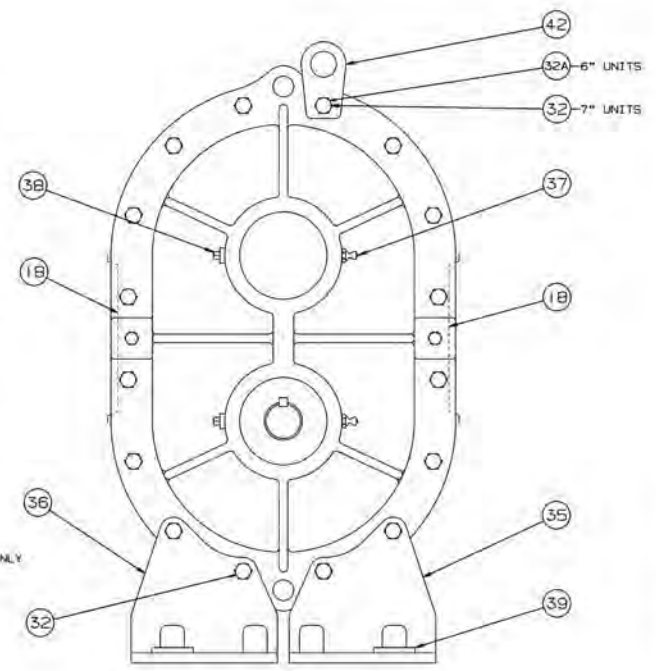
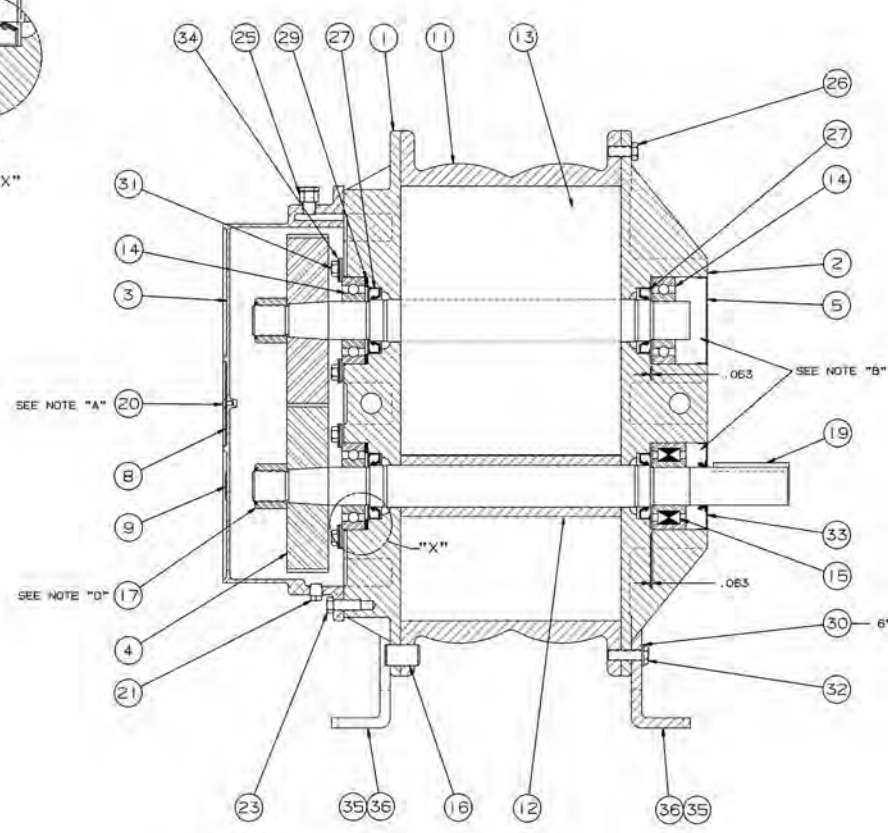
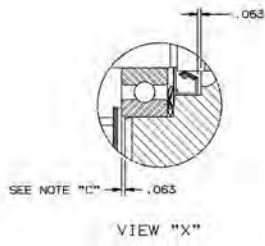

- NOTES
- A INSTALL ITEM #20 (SCREW) IN ASSEMBLY
 - B SEE OPERATING MANUAL IRB-103 FOR LUBRICATION INSTRUCTION
 - C INSTALL BEARINGS AS SHOWN BEFORE SETTING END CLEARANCE
 - D NUT TO BE TORQUED TO:
6"---400 LB. FT.
7"---550 LB. FT.

- ① 35779
- ② 33862V
- ③ 35500V

WFL NO. 6566285 CONFIDENTIAL THIS DOCUMENT CONTAINS CONFIDENTIAL INFORMATION OF ROOTS DIVISION, DRESSER INDUSTRIES, INC. IT SHALL BE HELD IN STRICTEST CONFIDENCE, AND BE USED ONLY IN CONNECTION WITH ROOTS DIVISION BUSINESS.		DATE: 08-12-03 DESIGNED BY: J. H. HARRIS DRAWN BY: J. H. HARRIS CHECKED BY: J. H. HARRIS APPROVED BY: J. H. HARRIS		DO NOT SCALE FOR DIMENSIONS ALL DIMENSIONS UNLESS OTHERWISE SPECIFIED PART: 64792023 SECTIONAL ASSEMBLY FOR 6" & 7" M-BALL BLOWER WITH TAPER SHAFT P.T.	
REF. DIMS (1) FINISH (2) ANALYTI (3) FINISH (4) DIA. POSITION (5) STRAIGHTEN	Q CONSPICUITY 1 HORIZONTAL LINE 2 PROFILE OF LINE 3 PROFILE OF A SURFACE 4 DIAMETER 5 FINISH IN WORK AREA	11 ADDED ITEM 552 12 REMOVED ITEM 44 13 ADDED ITEM 48	AXP 02/03 7831V ALR 02/03 7522V REP 04/03 7419V	08/12/03 08/12/03 08/12/03	DRESSER ROOTS ROOTS DIVISION DRESSER EQUIPMENT GROUP A HALLIBURTON COMPANY HOUSTON, TX USA 64792023 REV H

Assembly of UNIVERSAL RAI Blowers, 6" and 7" Diameter

ROOTS™ UNIVERSAL RAI® ROTARY POSITIVE BLOWERS

Frames 22 thru 718

BASIC BLOWER DESCRIPTION

Universal RAI® blowers are heavy-duty rotary blowers designed with detachable rugged steel mounting feet that permit easy, in-field adaptability to vertical or horizontal installation requirements.

Because of the detachable mounting feet, these units can be easily adapted to any of four drive shaft positions: right, left, bottom, or top. The compact, sturdy design is engineered for continuous service when operated in accordance with speed and pressure ratings.

The basic model consists of a cast iron casing, carburized and ground alloy steel spur timing gears secured to steel shafts with a taper mounting and locknut, and cast iron involute impellers. Oversized antifriction bearings are used, with a cylindrical roller bearing at the drive shaft to withstand V-belt pull. The Universal RAI® features splash oil lube on the gear end and grease lube on the drive end. ROOTS'



exclusive "figure-eight" gearbox design improves oil distribution to maximize gear and bearing life. After testing, the unit is sprayed with a protective paint, and boxed or skid mounted for delivery.

Available accessories include driver, relief valve, inlet and discharge silencers, inlet filter, check valve, extended base, V-belt or flexible coupling and drive guards.

OPERATING PRINCIPLE

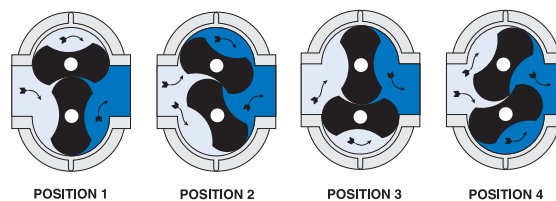

POSITION 1 POSITION 2 POSITION 3 POSITION 4

Two figure-eight lobe impellers mounted on parallel shafts rotate in opposite directions. As each impeller passes the blower inlet, it traps a definite volume of air and carries it around the case to the blower outlet, where the air is discharged. With constant speed operation, the displaced volume is essentially the same regardless of pressure or temperature.

Timing gears control the impellers relative positions and maintain small but definite clearances. This allows operation without lubrication requirements inside the unit casing.

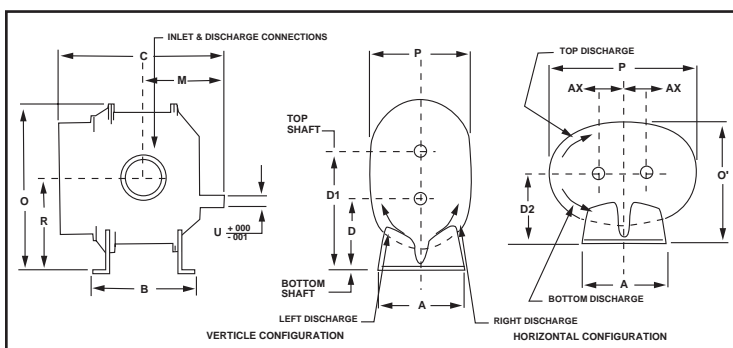

Frame	A	A'	B	C	D	D1	D2	M	O	O'	P	P'	R	U	INLET DISCH.	AX	WGT
22U	5.13	5.13	5.00	9.75	3.75	6.25	3.75	5.13	9.63	6.88	6.25	9.25	5.00	.625	1.0 NPT	1.25	32
24U	5.13	5.13	7.00	11.75	3.75	6.25	3.75	6.13	9.63	6.88	6.25	9.25	5.00	.625	2.0 NPT	1.25	43
32U	7.25	7.25	6.75	11.25	5.00	8.50	5.00	5.81	12.81	8.88	7.75	12.13	6.75	.750	1.25 NPT	1.75	69
33U	7.25	7.25	7.63	12.13	5.00	8.50	5.00	6.25	12.81	8.88	7.75	12.13	6.75	.750	2.0 NPT	1.75	74
36U	7.25	7.25	10.00	14.63	5.00	8.50	5.00	7.56	12.81	8.88	7.75	12.13	6.75	.750	2.5 NPT	1.75	102
42U	8.00	8.00	7.25	13.00	6.25	10.25	6.25	6.86	15.06	10.63	8.75	13.63	8.25	.875	1.5 NPT	2.00	88
45U	8.00	8.00	10.00	15.50	6.25	10.25	6.25	8.00	15.06	10.63	8.75	13.63	8.25	.875	2.5 NPT	2.00	109
47U	8.00	8.00	11.75	17.63	6.25	10.25	6.25	9.25	15.06	10.50	8.50	13.63	8.25	.875	3.0 NPT	2.00	128
53U	10.50	10.50	8.38	15.38	6.25	11.25	6.75	8.18	17.38	11.88	10.25	17.25	8.75	1.125	2.5 NPT	2.50	143
56U	10.50	10.50	11.00	18.00	6.25	11.25	6.75	9.19	17.38	12.25	11.00	17.25	8.75	1.125	4.0 NPT	2.50	170
59U	10.50	10.50	14.00	21.18	6.25	11.25	6.75	11.19	17.38	12.25	11.00	17.25	8.75	1.125	4.0 NPT	2.50	204
65U	11.00	11.00	10.00	18.38	8.75	14.75	8.75	9.19	21.63	15.13	12.75	19.75	11.75	1.375	3.0 NPT	3.00	245
68U	11.00	11.00	13.00	21.38	8.75	14.75	8.75	10.82	21.63	15.13	12.75	19.75	11.75	1.375	5.0 NPT	3.00	285
615U	11.00	11.00	20.00	28.38	8.75	14.75	8.75	14.32	21.63	16.25	15.00	19.75	11.75	1.375	6.0 FLG	3.00	425
76U	14.00	21.00	11.75	19.94	11.00	18.00	11.00	10.00	26.13	20.69	19.38	23.25	14.50	1.562	4.0 NPT	3.50	400
711U	14.00	21.00	16.75	25.19	11.00	18.00	11.00	12.75	26.13	19.50	17.00	23.25	14.50	1.562	6.0 FLG	3.50	530
718U	14.00	21.00	23.75	32.19	11.00	18.00	11.00	16.25	26.13	19.50	17.00	23.25	14.50	1.562	8.0 FLG	3.50	650



Roots

Frame Size	Speed	4 PSI		5 PSI		6 PSI		7 PSI		8 PSI		9 PSI		10 PSI		12 PSI		13 PSI		14 PSI		15 PSI		VACUUM DATA			
		CFM	BHP	CFM	BHP	CFM	BHP	CFM	BHP	CFM	BHP	CFM	BHP	CFM	BHP	CFM	BHP	CFM	BHP	CFM	BHP	CFM	BHP	INHG	V	BHP	
22	2950	31	0.9	29	1.1	27	1.3	26	1.5	24	1.7	23	1.9	21	2.1										13	20	1.3
	3550	40	1.0	39	1.3	37	1.5	35	1.8	34	2.0	32	2.3	31	2.5	28	3.0								14	28	1.7
	5275	68	1.6	66	2.0	64	2.4	63	2.7	61	3.1	60	3.5	59	3.8	56	4.6								15	53	2.8
24	2950	68	1.7	65	2.1	63	2.5	60	2.9															14	48	2.8	
	3550	88	2.0	85	2.5	82	3.0	79	3.5															14	67	3.4	
	5275	143	3.1	140	3.9	137	4.6	134	5.4															15	119	5.5	
32	1750	54	1.4	51	1.7	48	2.1	45	2.4	43	2.8	41	3.1	39	3.5	35	4.1							13	37	2.2	
	2950	108	2.4	105	3.0	102	3.6	99	4.2	97	4.7	95	5.3	93	5.9	89	7.1	87	7.6	86	8.2	84	8.8	15	84	4.3	
	3550	135	3.0	132	3.7	129	4.4	126	5.1	124	5.8	122	6.5	120	7.2	116	8.6	114	9.3	113	10.0	111	10.6	16	108	5.6	
33	1750	75	1.9	71	2.4	67	2.9	64	3.3	61	3.8	58	4.3	56	4.7	51	5.7							13	53	3.0	
	2950	149	3.3	145	4.1	141	4.9	138	5.7	135	6.5	132	7.3	130	8.1	125	9.7							15	119	5.9	
	3550	186	4.1	182	5.0	178	6.0	175	6.9	172	7.9	169	8.8	167	9.8	162	11.7							15	156	7.2	
36	1750	132	3.2	126	3.9	121	4.7	117	5.5															14	95	5.4	
	2950	254	5.5	249	6.8	244	8.1	239	9.4															15	212	9.8	
	3550	316	6.7	310	8.3	305	9.9	300	11.5															15	273	11.9	
42	1750	78	1.9	74	2.4	71	2.8	69	3.3	66	3.7	64	4.2	61	4.7	57	5.6	55	6.0					14	55	3.2	
	2950	150	3.3	147	4.1	144	4.9	141	5.7	139	6.5	136	7.2	134	8.0	130	9.6	128	10.3	126	11.1	124	11.9	16	121	6.2	
	3550	187	4.1	183	5.1	180	6.0	177	7.0	175	7.9	172	8.8	170	9.8	166	11.6	164	12.6	162	13.5	160	14.4	16	157	7.6	
45	1750	161	3.8	155	4.7	150	5.6	145	6.6	140	7.5	136	8.4	132	9.3									14	121	6.4	
	2950	306	6.7	300	8.2	295	9.8	290	11.3	285	12.9	281	14.4	277	16.0									16	253	12.5	
	3550	379	8.2	373	10.1	368	12.0	363	13.9	358	15.7	354	17.6	349	19.5									16	326	15.2	
47	1750	215	5.0	208	6.2	201	7.4	195	8.6															14	165	8.4	
	2950	407	8.8	399	10.8	392	12.9	386	14.9															15	348	15.4	
	3550	502	10.9	495	13.3	488	15.8	482	18.3															15	444	18.8	
53	1170	113	2.7	108	3.4	103	4.1	99	4.8	96	5.4	92	6.1	89	6.8	82	8.1							13	85	4.3	
	1750	189	4.2	184	5.2	180	6.2	176	7.2	172	8.2	168	9.2	165	10.3	159	12.3	156	13.3	153	14.3			15	151	7.5	
	2850	334	7.4	329	9.0	325	10.7	321	12.3	317	14.0	313	15.6	310	17.2	304	20.5	301	22.1	298	23.8	295	25.4	16	291	13.4	
56	1170	196	4.6	188	5.7	182	6.9	175	8.0	170	9.1	164	10.2	159	11.4	150	13.6							14	146	7.8	
	1750	324	7.0	316	8.7	310	10.4	304	12.1	298	13.8	292	15.5	287	17.2	278	20.5	273	22.2					15	266	12.6	
	2850	567	12.2	560	15.0	553	17.7	547	20.5	541	23.2	536	26.0	530	28.7	521	34.2	517	37.0					16	501	22.4	
59	1170	299	6.7	290	8.4	281	10.0	273	11.7															14	237	11.4	
	1750	486	10.3	477	12.8	469	15.2	461	17.7															15	414	18.4	
	2850	842	18.0	832	22.0	824	26.0	816	30.0															15	770	30.8	
65	1170	223	5.2	215	6.4	208	7.7	202	8.9	196	10.2	190	11.5	185	12.7	175	15.2	171	16.5	166	17.7			14	171	8.7	
	1750	365	8.0	358	9.9	351	11.8	344	13.7	339	15.6	333	17.4	328	19.3	318	23.1	313	24.9	309	26.8	305	28.7	16	297	15.1	
	2350	513	11.4	505	13.9	499	16.4	492	19.0	486	21.5	481	24.0	475	26.5	465	31.6	461	34.1	456	36.6	452	39.1	16	445	20.6	
68	1170	358	8.3	345	10.3	334	12.3	324	14.3	314	16.3	305	18.3	297	20.3	281	24.4	274	26.4	267	28.4			14	275	13.9	
	1750	587	12.7	574	15.7	563	18.7	553	21.8	544	24.8	535	27.8	526	30.8	510	36.8	503	39.8	496	42.9			16	478	24.0	
	2350	824	17.8	811	21.8	800	25.9	790	29.9	781	34.0	772	38.0	763	42.1	747	50.2	740	54.2	733	58.3			16	715	32.8	
615	1170	670	15.4	647	19.1	626	22.9	607	26.7															11	581	20.5	
	1750	1099	23.4	1076	29.1	1055	34.7	1036	40.4															12	989	33.7	
	2350	1543	32.4	1520	40.0	1499	47.6	1480	55.2															12	1433	46.0	
76	1170	393	8.6	383	10.6	374	12.7	367	14.8	359	16.8	352	18.9	346	21.0	333	25.1	328	27.2	322	29.2	317	31.3	15	319	15.4	
	1750	628	13.4	618	16.5	609	19.6	601	22.7	594	25.8	587	28.9	580	32.0	568	38.1	562	41.2	557	44.3	552	47.4	16	543	24.9	
	2050	749	16.2	740	19.8	731	23.4	723	22.0	716	30.6	709	34.3	702	37.9	690	45.1	684	48.7	678	52.4	623	56.0	16	664	29.5	
711	1170	738	15.5	723	19.2	710	23.0	697	26.8	686	30.5	675	34.3	665	38.1									15	623	27.9	
	1750	1166	23.9	1151	29.5	1138	35.2	1125	40.8	1114	46.4	1103	52.0	1093	57.7									16	1035	45.0	
	2050	1387	28.6	1372	35.2	1359	41.8	1347	48.4	1335	55.0	1324	61.6	1314	68.2									16	1256	53.1	
718	1170	1224	25.0	1202	31.1	1183	37.2																	12	1122	36.3	
	1750	1920	38.2	1898	47.4	1879	56.5																	12	1818	54.8	
	2050	2280	45.5	2258	56.2	2239	66.9																	12	2178	64.7	

NOTES: 1. Performance based on inlet air at standard pressure of 14.7 psia, standard temperature of 68° F, and specific gravity of 1.0.
2. Vacuum ratings based on inlet air at standard temperature of 68° F, discharge pressure of 30" Hg and specific gravity of 1.0.

DESIGN AND CONSTRUCTION FEATURES

1. Detachable steel mounting feet
2. Rigid one-piece cast iron casing
3. Anti-friction bearings
4. Splash oil lubricated spur timing gears
5. Connections in standard pipe sizes
6. Ground steel shafts
7. Straight, precision machined two-lobe impellers



Roots

Dresser ROOTS

2135 Hwy 6 South
Houston, TX 77077
Ph: 281-966-4700
Fx: 281-966-4309
Toll Free (US): 877-363-ROOT(S)

Dresser ROOTS

Connersville
900 West Mount Street
Connersville, IN 47331
Ph: 765-827-9200
Fx: 765-827-9266

Dresser ROOTS

Holmes Operation
PO Box B7
Off St. Andrews Rd
Turnbridge, Huddersfield
England HD1 6RB
Ph: +44-1484-422222
Fx: +44-1484-422668

S-12K84
September 2003
Copyright 2003 Dresser, Inc. All rights reserved.
Dresser Design and Universal RAI® are registered trademarks of Dresser, Inc.
ROOTS™ is a trademark of Dresser, Inc.
All information subject to change without notice.

website: www.rootsblower.com ♦ email: ROOTS@dresser.com



PERFORMANCE BASED ON AIR,
 INLET AT 14.7 PSIA & 68°F
 DECEMBER 2004

PRESSURE PERFORMANCE
FRAME 718 U-RAI
 MAX. PRESSURE RISE = 6 PSI
 MAX. SPEED = 2050 RPM

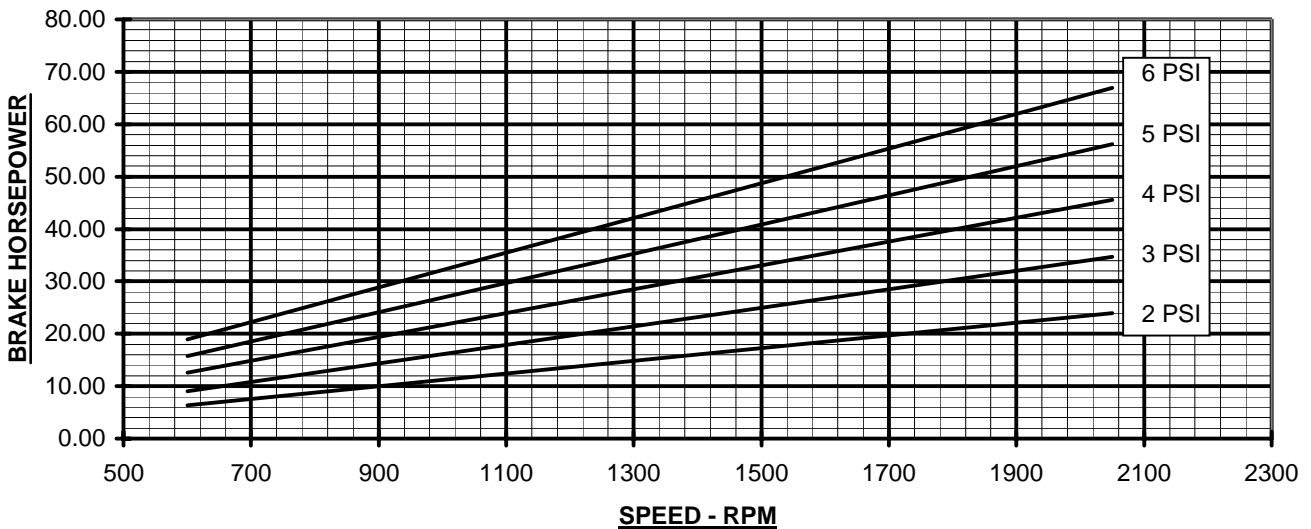
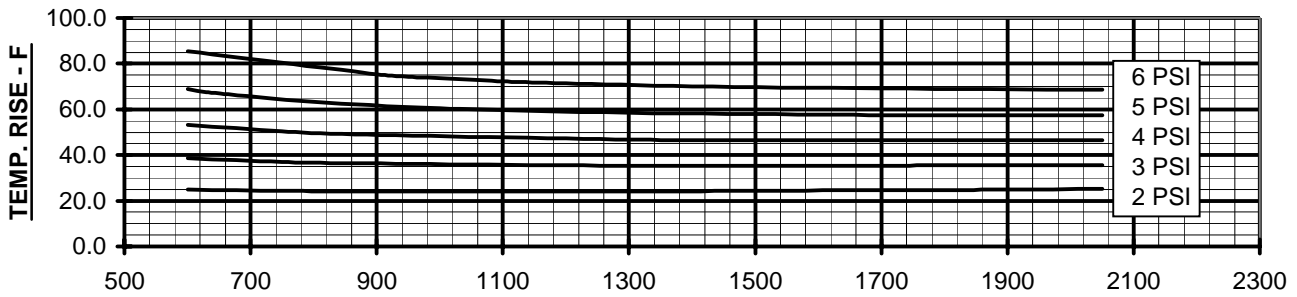
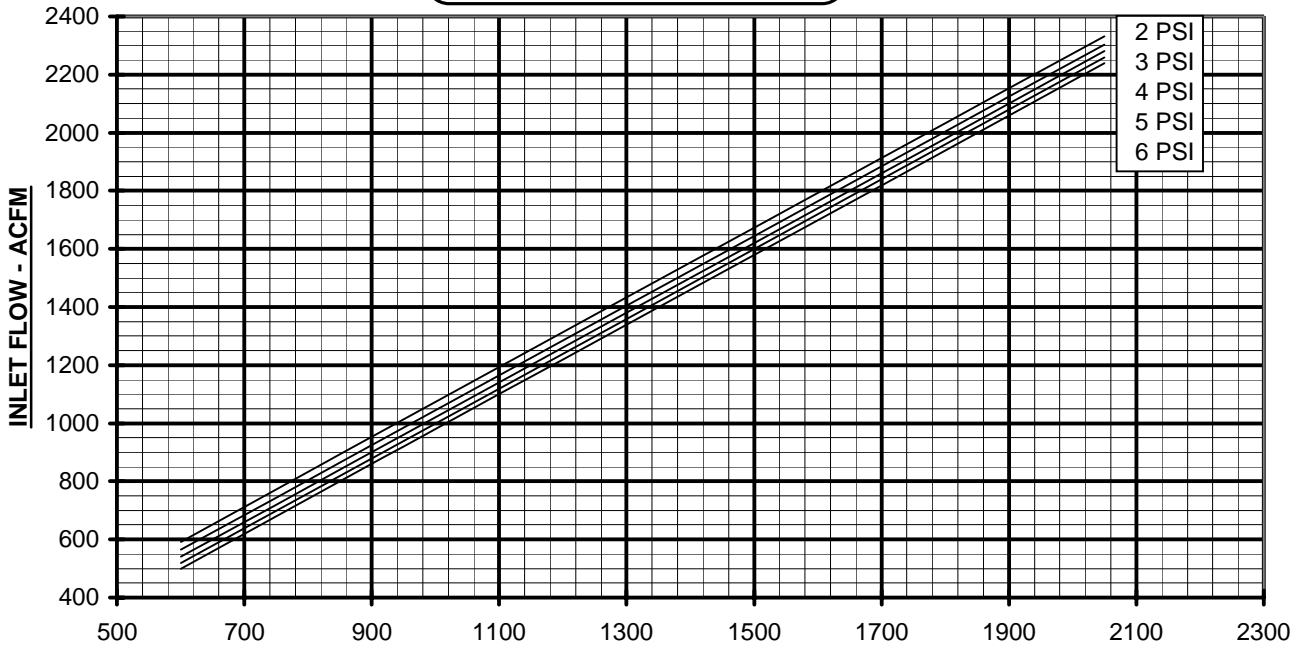



VACUUM PERFORMANCE
FRAME 718 U-RAI
 MAX. VACUUM = 12" HG
 MAX. SPEED = 2050 RPM

PERFORMANCE BASED ON AIR,
 INLET AT 68°F
 DISCHARGE PRESSURE = 30" HG ABS.
 DECEMBER 2004

